

electriQ

USER MANUAL

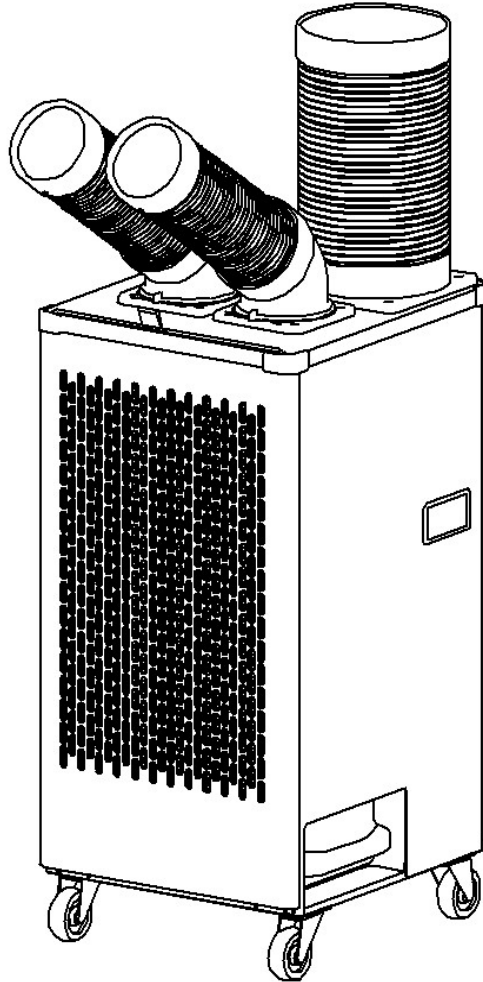

electriQ 12,000 BTU PORTABLE INDUSTRIAL AIR CONDITIONER CMAC12M

Thank you for choosing electriQ
Please read this user manual before using this innovative Air Conditioner and keep it
safe for future reference.

Visit our page, www.electriQ.co.uk, for our entire range of Intelligent Electricals.

SETTLING IN OK?

We hope this has been helpful to you.

We would love to see how you're getting on with your new purchase, so please share any snaps you have on the platform of your choice below.

Our community awaits your uploads - Snap, tag and hashtag away!



@electriQUK

#electriQUK

WE'RE HERE TO HELP

Should you have any problems or questions with your purchase, please contact a member of our customer service team.

☎ 0330 390 3061

✉ support@electriQ.co.uk

Mon-Fri | 9am to 5pm

Unit 2A, Trident Business Park,
Neptune Way, Leeds Road,
Huddersfield, HD2 1UA

CONTENTS

SAFETY INFORMATION	4
FEATURES	7
APPLIANCE DIAGRAM	7
INSTALLATION	8
OPERATION	9
EMPTYING THE INTERNAL WATER TANK	11
CLEANING AND MAINTENANCE	11
TROUBLESHOOTING	12
SUPPORT	13
TECHNICAL SPECIFICATION	13

SAFETY INSTRUCTIONS







Important!

- Carefully read the instructions before operating the unit
- This appliance is for indoor use only.
- Rating: This unit must be connected only to a 220-240 V / 50 Hz earthed outlet. The fuse rating is on the plug itself.
- Installation must be in accordance with the wiring regulations, gas regulations and any other applicable regulations of the country where the unit is used.
- If you have any doubt about the suitability of your electrical supply, have it checked and, if necessary, modified by a qualified electrician.
- You must follow the venting and set-up instructions; failure to do so will cause damage to the unit, which is not covered under your warranty.
- This air conditioner has been tested and is safe to use. However, as with any electrical appliance - use it with care.
- Do not obstruct any of the ventilation openings.
- The airflow should never be restricted, for example, by venting the unit into a condenser box or reducing the hose diameter, as this can damage the unit.
- Disconnect the power from the appliance before dismantling, assembling or cleaning.
- Avoid touching any moving parts of the appliance.
- Never insert fingers, pencils or any other objects through the guard.
- **WARNING:** Do not pierce or burn any part of the unit.
- This appliance is not intended for use by persons (including children) with reduced physical, sensory or mental capabilities. It is also not intended for use by those with a lack of experience and knowledge unless they have been given supervision or instruction concerning the use of the appliance by a person responsible for their safety.
- Do not leave children unsupervised with this appliance.
- Do not clean the unit by spraying it or immersing it in water.
- Never connect the unit to an electrical outlet using an extension cord. If an outlet is not available, a qualified electrician should install one.
- Never operate this appliance if the cord or plug is damaged. Ensure the power cord is not stretched or exposed to sharp objects/edges.
- A damaged supply cord should be replaced by the manufacturer or a qualified electrician to avoid a hazard.
- An authorised service representative should perform any service besides regular cleaning or filter replacement. Failure to comply could result in a voided warranty.
- Do not use the appliance for any purpose other than its intended use.
- **The air conditioner unit must always be stored and transported upright; otherwise, the compressor may suffer irreparable damage. If in doubt, we suggest waiting at least 24 hours before starting the unit.**

- Do not move the air conditioner while it is operating. When operating, the castors should be locked in position.
- Ensure the unit is positioned on a flat, level surface and does not interfere with walkways.
- This air conditioner is not designed to be used on boats or any other type of transportation.
- Do not restart the air conditioning unit unless 3 minutes have passed since it was turned off. This prevents damage to the compressor.
- Never use the mains plug as a switch to start and turn off the air conditioning unit. Use the provided ON/OFF button located on the control panel.
- Always place the unit on a dry, stable, flat surface.
- The appliance should not be installed in the laundry or wet rooms.
- The appliance must be placed in a room without sources of ignition (e.g., open flames, an operating gas appliance, or an operating electric heater).
- R290 refrigerant gas complies with European environmental directives.
- R290 has a low GWP (Global Warming Potential) of 3.
- This air conditioner contains around 280 g of R290 refrigerant gas.
- Do not use or store in an unventilated space with an area smaller than 18.2 m² per unit.
- **WARNING:** The appliance must be stored in a room without continuously operating ignition sources, such as open flames, an operating gas appliance, or electric heaters.
- The room must be designed to prevent stagnation or possible leaks of refrigerant gas, as there could be a danger of fire or explosion should the refrigerant come into contact with electric heaters, stoves, or other ignition sources.
- Only store and use the unit whilst upright; do not lay it down or tip it.
- Do not place the unit near ovens or other heat sources. This may be dangerous, but it will also cause the unit to work harder and use more energy.
- Do not place the unit in direct sunlight; this can affect its appearance, make it work harder, and reduce its energy efficiency.
- Refrigerant gas may be odourless.
- Do not use the product and contact the retailer for advice if damage has occurred to the unit, which may have compromised the refrigerant system.
- Any repairs or maintenance must only be done on the unit by a suitably qualified engineer. Before opening and servicing the unit, the authorised engineer must possess a copy of the manufacturer's service manual and follow its safety information to ensure all hazards are minimised.
- The refrigerant system should not be perforated or punctured.
- At the end of the unit's lifetime, always dispose in line with local regulations.
- Ensure all storage conditions in the manual are followed.
- **WARNING:** Do not use means to accelerate the defrosting process or to clean the unit.

ENERGY SAVING AND UNIT SAFETY PROTECTION TIPS

- Do not cover or restrict the airflow from the outlet or inlet grills.
- For maximum performance the minimum distance from a wall or objects should be 50cm.
- Keep the filters clean. Under normal conditions, filters should only need cleaning once every three weeks (approximately). Since the filters remove airborne particles, more frequent cleaning may be necessary, depending on the air quality.
- For the initial start-up, set the fan speed to maximum and the thermostat to 5 degrees lower than the current temperature. After, set the fan switch to low and set the thermostat to your desired setting.
- To protect the unit, we recommend not using the cooling function when the ambient temperature exceeds 35°C. The unit's performance may be affected at lower temperatures than this. If a very hot day is predicted, running the unit overnight in the desired room is recommended.

	<p>WARNING: This appliance contains flammable refrigerant. If this leaks and comes into contact with an external ignition source, there is a fire risk.</p>
	<p>CAUTION: The operation manual should be read thoroughly.</p>
	<p>CAUTION: Any service personnel working on the unit should read the service manual prior.</p>
	<p>CAUTION: Information on operation and servicing is in the manual.</p>

FEATURES

- 3 in 1 Cooling, Fan, Dehumidifier. The CMAC12M is great for Rooms up to 30 m².
- two-speed fan: Balancing quiet operation with performance.
- 24 Hours Start / Stop Timer.
- Digital Thermostat.
- Auto-Restart to retain the settings in the event of power failure.
- Castors for Enhanced Portability.
- Durable metal casing.
- Twin cold air ducts allow the distribution of cold air.

HOSE SPECIFICATIONS

Hose	Hose External Diameter (mm)	Supplied Hose Length	Max Permitted Hose Length (cm)
Cold Air	120	37 – 48 cm	200
Hot Air	200	37 – 48 cm	300

APPLIANCE DIAGRAM

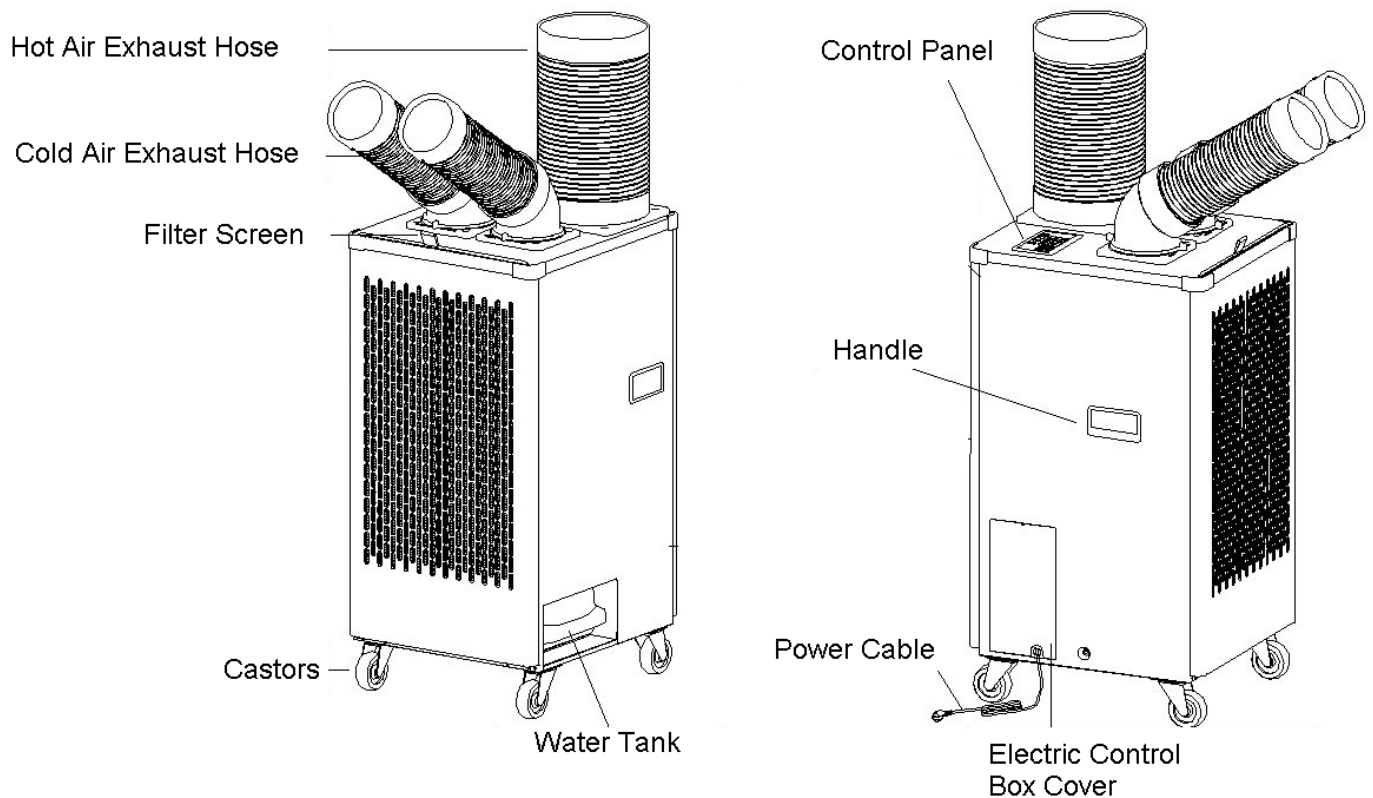

INSTALLATION

COLD AIR OUTLETS

1. Line up the dimple on the Elbow with the notch on the Hose connector on the top of the air conditioner.
2. Rotate anticlockwise until a click can be heard, indicating the elbow has locked into place.
3. Insert the Cold Air Hose into the Elbow, again lining up the dimple with the notch in the Elbow.
4. Rotate the pipe anticlockwise to fix it in place.
5. The pipe can then be extended and pointed in the desired direction.
6. Repeat for the second air outlet.

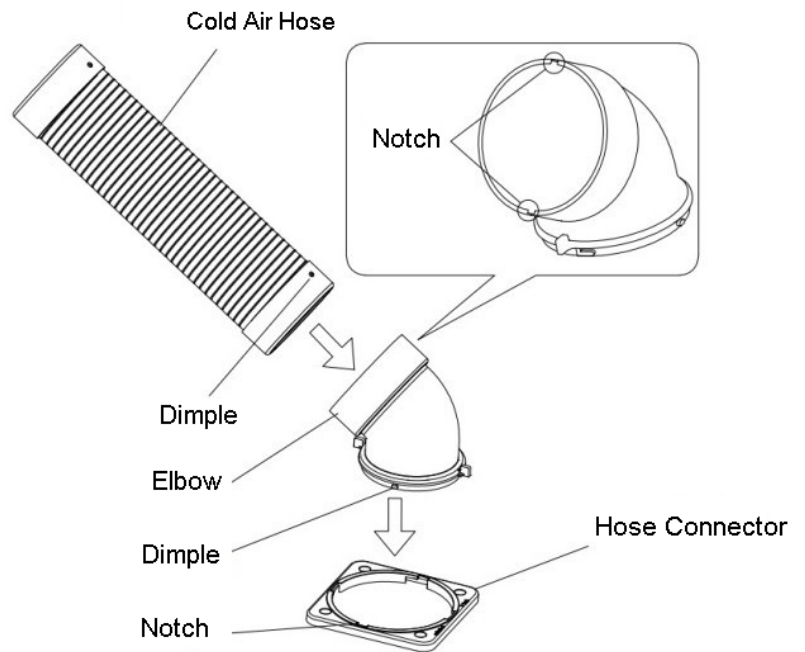

HOT AIR OUTLET

1. Push the Hot Air Hose onto the Hot air outlet on the top of the appliance.
2. Extend the pipe and route it outside.

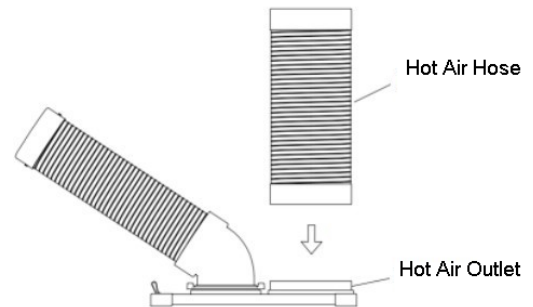

NOTES:

- The best form of installation is through a wall duct. By properly venting, you expel hot air from your room while efficiently cooling it.
- In dry mode, your air conditioner should be used without the vent pipe. During dry mode, ensure the water tank is monitored and regularly emptied. Permanent plumbing can also be installed for dry mode, or an external uplift water pump can be set up for unattended use.





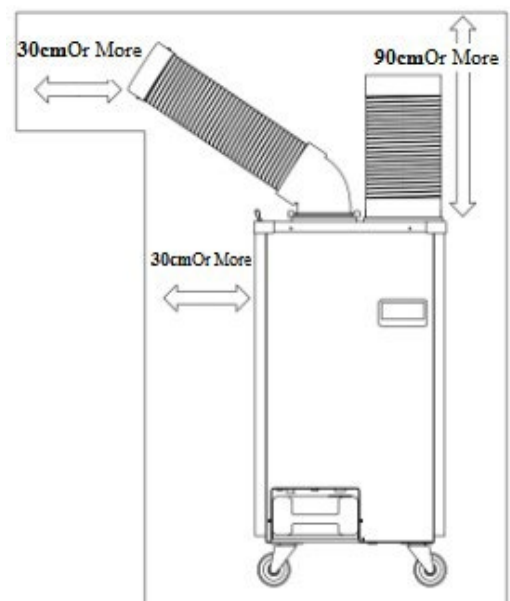



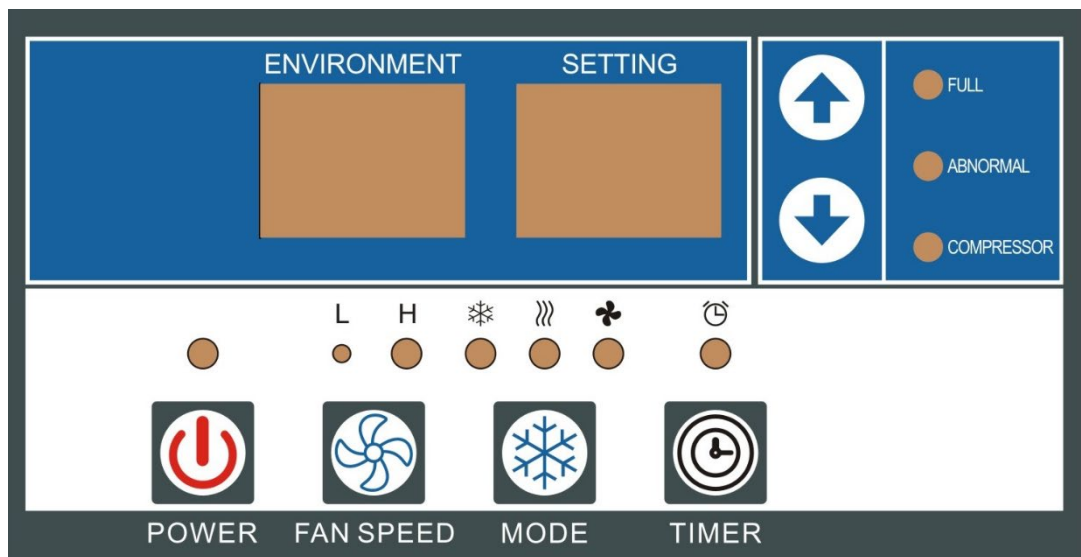





IMPORTANT SAFEGUARDS

If hoses are extended above the permitted length, the unit may malfunction, which can invalidate the warranty. The outlet vent must be well-ventilated and not obstructed, as this will cause the unit to overheat. Keep the hoses as straight and short as possible, and avoid bending the air hose by more than 45 degrees to maintain the unit's performance. Excessive bends in the hose may prevent the unit from expelling hot air, leading to internal damage and invalidating the warranty. Ensure that sufficient space is left in from the end of the vent pipes (30cm – Cold air, 90cm Hot air)







OPERATION

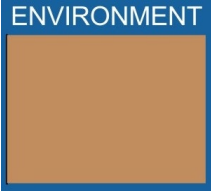

 POWER	<p>Press the POWER button to turn the unit ON or OFF.</p>						
 MODE	<p>Press the MODE button to cycle between the three modes. The indicator for the selected mode will illuminate.</p> <table border="1" data-bbox="231 907 1495 1321"> <tr> <td data-bbox="231 907 359 1064">  COOL </td> <td data-bbox="359 907 1495 1064"> <p>The room is cooled by cold air expelled through the cold air outlets and hot air expelled through the Hot Air Pipe. The Up and Down buttons can be used to set the desired room temperature between 15 and 35 degrees, and the SPEED button can be used to change the fan speed.</p> </td> </tr> <tr> <td data-bbox="231 1064 359 1187">  FAN </td> <td data-bbox="359 1064 1495 1187"> <p>The fan speed can be changed by pressing the SPEED button.</p> </td> </tr> <tr> <td data-bbox="231 1187 359 1321">  DRY </td> <td data-bbox="359 1187 1495 1321"> <p>The unit removes moisture from the air. When using it as a dehumidifier, the Hot air Pipe should not be used. We advise that continuous drainage be set up when using the Dry mode.</p> </td> </tr> </table>	 COOL	<p>The room is cooled by cold air expelled through the cold air outlets and hot air expelled through the Hot Air Pipe. The Up and Down buttons can be used to set the desired room temperature between 15 and 35 degrees, and the SPEED button can be used to change the fan speed.</p>	 FAN	<p>The fan speed can be changed by pressing the SPEED button.</p>	 DRY	<p>The unit removes moisture from the air. When using it as a dehumidifier, the Hot air Pipe should not be used. We advise that continuous drainage be set up when using the Dry mode.</p>
 COOL	<p>The room is cooled by cold air expelled through the cold air outlets and hot air expelled through the Hot Air Pipe. The Up and Down buttons can be used to set the desired room temperature between 15 and 35 degrees, and the SPEED button can be used to change the fan speed.</p>						
 FAN	<p>The fan speed can be changed by pressing the SPEED button.</p>						
 DRY	<p>The unit removes moisture from the air. When using it as a dehumidifier, the Hot air Pipe should not be used. We advise that continuous drainage be set up when using the Dry mode.</p>						
 FAN SPEED	<p>Press the SPEED button to cycle through the two fan speeds. Each time the SPEED button is pressed, the indicator will change to show the currently selected speed. The fan speed can be altered between Low and High.</p>						
 TIMER	<p>The timer functions cannot be combined or repeated.</p> <p>POWER ON TIMER With the appliance on standby, press the TIMER button to set the power-on timer. Use the Up and Down buttons to adjust the timer's duration (0.5 to 24 hours). The Timer indicator will turn on, and the unit will start after the selected hours.</p> <p>POWER OFF TIMER Press the TIMER button to set the power-off timer so the appliance runs with the desired settings. Use the Up and Down buttons to adjust the timer's duration (0.5 to 24 hours). The timer indicator will illuminate, and the unit will stop after the selected number of hours.</p>						
	<p>They are used to adjust temperature in COOL mode and set the TIMER duration. The buttons are not used in FAN or DRY modes.</p>						

INDICATORS

	Shows the current room temperature.
	It shows the desired room temperature during cooling Mode. While setting the timer, it displays the duration of the timer.
	The light illuminates when the water tank is full and the unit stops operating. To extinguish the light and restart the operation, remove the water tank, empty it, and replace it.
	It will illuminate when a fault is detected, such as the room temperature being outside the operating range. Unplug the unit and resolve the issue before restarting it.
	Will illuminate to show that the compressor operates to cool the air in Cool and Dry modes.

MULTI PROTECTIVE FUNCTIONS

FROST PROTECTION

In COOL, DRY, or AUTO modes, if the exhaust temperature is too low, the machine will automatically stop operating until the temperature has risen.

OVERFLOW PROTECTION

When the water in the internal water tank exceeds the warning level, the machine will stop operating and sound an alarm. To resume operation, empty the internal water tank. After emptying the water, the machine will automatically return to its original state.

AUTO-DEFROST

The machine has an automatic defrosting function. If the temperature of the internal coils drops too low during operation, the unit will enter auto defrost, and the heating symbol will flash on the control panel.

AUTOMATIC THERMAL PROTECTION

The machine has automatic thermal protection to protect its service life. If the temperature within the unit is outside of the specified range, the compressor and the lower motor will stop operating. After the machine's temperature recovers, the appliance will automatically return to normal operation.

COMPRESSOR PROTECTION

There is a 3-minute delay start protection function to prevent damage to the compressor.

EMPTYING THE INTERNAL WATER TANK

MANUAL DRAINAGE:

When the internal water tank is full, the unit will stop working.

Shut off and unplug the unit. Do not move the appliance, as this may cause the water in the internal tank to spill out. Remove the water tank from the base of the unit and empty it into a sink or drain. Replace the water tank in the unit before plugging it back in and restarting the operation.

CONTINUOUS DRAINAGE:

Remove the water tank from the unit and the rubber cap from the end of the drainage spout. Connect the drainage pipe to the spout. Feed the drainage pipe through the hole in the side of the unit from the inside before sliding the water tank back into place. The drain is gravity-fed, so it can be routed downwards to a suitable drain. Alternatively, the pipe can be attached to an external uplift pump (not supplied) to pump the water uphill to a suitable drainage point.

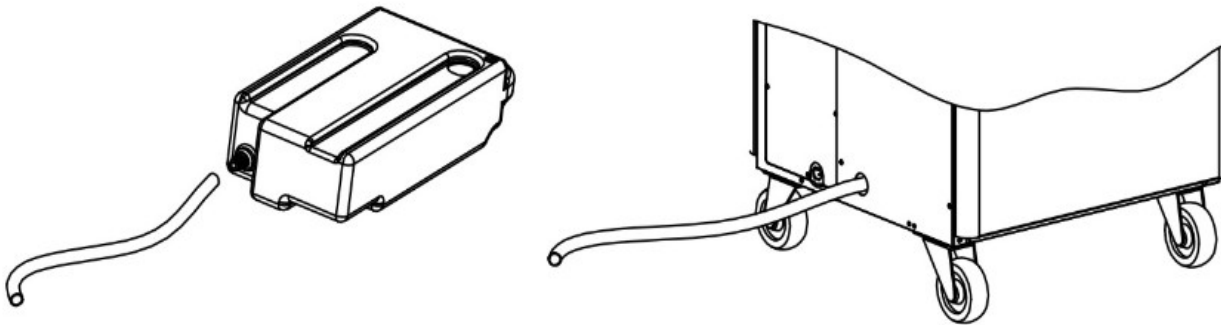

NOTE: This model has a self-evaporative function, which reduces the need to empty the water tank. If the unit is vented correctly, most water is reused to cool the condenser coils, and any excess is evaporated. Please do not use continuous drainage if you intend to use the self-evaporating facility.

CLEANING AND MAINTENANCE

PLEASE TURN OFF THE UNIT AND UNPLUG FROM THE MAINS BEFORE CLEANING OR PERFORMING ANY MAINTENANCE

CLEAN THE SURFACE

Clean the machine's surface with a wet, soft cloth. Do not use chemicals such as benzene, alcohol, gasoline, etc.; otherwise, this may damage the surface or the internal workings of the machine.

AIR FILTER CLEANING

If the filter screen is clogged with dust, the air conditioner's effectiveness is reduced. The filter screen should be cleaned once every two weeks or as often as necessary in your environment.

END-OF-SEASON MAINTENANCE

1. Empty the internal water tank.
2. Then switch the unit to low fan mode.
3. Keep the unit in this mode for half a day - until the conduit is dried. Doing this helps to keep the inside of the unit dry and prevents mould from developing
4. Turn off the unit and pull out the plug.
5. Empty the water tank again.
6. Coil the wire, bind it together, and put it into the accessories space.
7. Separate the vent pipes and store them safely.
8. Cover the unit and keep it in a dry place.

TROUBLESHOOTING

Do not repair or disassemble the air conditioning. Unqualified repair will invalidate the warranty and may lead to failure, causing injuries and property damage. Only use it as directed in this user manual and only perform operations advised here.

Problems	Reasons	Solutions
The air conditioner does not work.	There is no electricity.	Please turn it on after connecting it to a socket with electricity.
	FULL indicator is illuminated	Discharge the water inside.
	The ambient temperature is too low or too high	Only use to use the machine within a temperature range of 18-45°C
	In cooling mode, the room temperature is lower than the desired temperature.	Change the desired temperature.
	In dry mode, the ambient temperature is low.	The ambient temperature must be above 18 °C. (60 °F).
The cooling effect is not good	There is direct sunlight.	Use curtains to reduce the direct sun heat.
	Doors or windows are open; there are a lot of people; or in cooling mode, there are other sources of heat (e.g. fridges)	Close doors and windows; increase air conditioning power
	The filter screen is dirty.	Clean or replace the filter screen.
	The air inlet or outlet is blocked.	Clear obstructions; make sure venting is correct as described in this user manual and the hose is not bent
Loud Noise	The air conditioning is not placed on a flat surface.	Put the air conditioning on a flat and hard place (to reduce noise).
The compressor does not work.	Overheat protection starts.	Wait 3 minutes until the temperature is lowered, then restart the machine.
Others	No refrigerant, or there is minimal refrigerant	Refer to Service Centre (check leakage, welding, vacuum pump, charge refrigerant according to nameplate)
	Anti-freezing protection	Waiting for defrosting. The function will recover automatically. No user input is needed.
	High-pressure protection	After the inside gas pressure comes down, it will function normally. No user input is needed.

If problems not listed in the table occur or recommended solutions do not work, please get in touch with the service centre.

APPENDIX



Disposal: Do not dispose of this product as unsorted municipal waste. Collection of such waste must be handled separately as special treatment is necessary. Recycling facilities are now available for all customers at which you can deposit your old electrical products. Customers can take any old electrical equipment to participating civic amenity sites run by their local councils. Please remember that this equipment will be further handled during the recycling process, so please be considerate when depositing your equipment. Please get in touch with the local council for details of your local household waste recycling centres.

electriQ UK SUPPORT

www.electriQ.co.uk/support

Please make these simple checks before calling the service line. If the unit still fails to operate, call the number below or complete the online form.

0330 390 3061



1. Has the unit been standing upright for at least 2 hours?
2. Is the unit plugged into the mains?
3. Is the fuse OK?
4. Switch the unit off and wait three minutes to see if the issue is resolved. Restart the unit.
5. Check if the water tank is full.

Office hours: 9 AM - 5 PM, Monday to Friday

www.electriQ.co.uk

Unit 2A, Trident Business Park,
Neptune Way, Leeds Road,
Huddersfield, HD2 1UA.

TECHNICAL DATA

Model	CMAC12M
Cooling capacity:	12,000 BTU
Input power:	1400 W
Fan	AC motor with two fan speeds.
Air flow volume:	600 m ³ /h
Input current:	6.2 A
Refrigerant:	R290/300g
Thermostat:	15 - 35°C
Maximum working pressure of suction/exhaust side:	1.0/2.5 MPa
Maximum Allowable Pressure	2.5 MPa
Power Supply:	AC 220-240V/50 Hz
Net Weight:	49 kg
Dimension(L*D*H):	430 x 493 x 944 mm
<p>The unit must be vented outside when in Air Cooling mode. For the purposes of EU regulation EN12102, this is a local air conditioner that produces less than 65dB(A) sound energy.</p> <div style="text-align: center;"></div>	